

### POWER MOS 7® IGBT

The POWER MOS 7® IGBT is a new generation of high voltage power IGBTs. Using Punch Through Technology this IGBT is ideal for many high frequency, high voltage switching applications and has been optimized for high frequency switchmode power supplies.

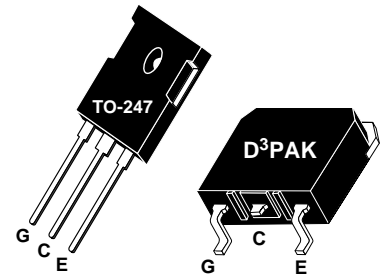

- Low Conduction Loss
- Low Gate Charge
- Ultrafast Tail Current shutoff
- 200 kHz operation @ 400V, 26A
- 100 kHz operation @ 400V, 41A
- SSOA rated

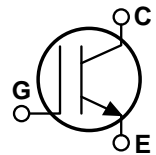

#### MAXIMUM RATINGS

All Ratings:  $T_C = 25^\circ\text{C}$  unless otherwise specified.

Symbol	Parameter	APT50GP60B_S	UNIT
$V_{CES}$	Collector-Emitter Voltage	600	Volts
$V_{GE}$	Gate-Emitter Voltage	$\pm 20$	
$V_{GEM}$	Gate-Emitter Voltage Transient	$\pm 30$	
$I_{C1}$	Continuous Collector Current <sup>⑦</sup> @ $T_C = 25^\circ\text{C}$	100	Amps
$I_{C2}$	Continuous Collector Current @ $T_C = 110^\circ\text{C}$	72	
$I_{CM}$	Pulsed Collector Current <sup>①</sup> @ $T_C = 150^\circ\text{C}$	190	
SSOA	Safe Operating Area @ $T_j = 150^\circ\text{C}$	190A@600V	
$P_D$	Total Power Dissipation	625	Watts
$T_J, T_{STG}$	Operating and Storage Junction Temperature Range	-55 to 150	$^\circ\text{C}$
$T_L$	Max. Lead Temp. for Soldering: 0.063" from Case for 10 Sec.	300	

#### STATIC ELECTRICAL CHARACTERISTICS

Symbol	Characteristic / Test Conditions	MIN	TYP	MAX	UNIT
$BV_{CES}$	Collector-Emitter Breakdown Voltage ( $V_{GE} = 0V, I_C = 500\mu\text{A}$ )	600			Volts
$V_{GE(TH)}$	Gate Threshold Voltage ( $V_{CE} = V_{GE}, I_C = 1\text{mA}, T_j = 25^\circ\text{C}$ )	3	4.5	6	
$V_{CE(ON)}$	Collector-Emitter On Voltage ( $V_{GE} = 15V, I_C = 50A, T_j = 25^\circ\text{C}$ )		2.2	2.7	
	Collector-Emitter On Voltage ( $V_{GE} = 15V, I_C = 50A, T_j = 125^\circ\text{C}$ )		2.1		
$I_{CES}$	Collector Cut-off Current ( $V_{CE} = 600V, V_{GE} = 0V, T_j = 25^\circ\text{C}$ ) <sup>②</sup>			500	$\mu\text{A}$
	Collector Cut-off Current ( $V_{CE} = 600V, V_{GE} = 0V, T_j = 125^\circ\text{C}$ ) <sup>②</sup>			2500	
$I_{GES}$	Gate-Emitter Leakage Current ( $V_{GE} = \pm 20V$ )			$\pm 100$	nA

 **CAUTION:** These Devices are Sensitive to Electrostatic Discharge. Proper Handling Procedures Should Be Followed.

APT Website - <http://www.advancedpower.com>

**DYNAMIC CHARACTERISTICS**

**APT50GP60B\_S**

Symbol	Characteristic	Test Conditions	MIN	TYP	MAX	UNIT	
C <sub>ies</sub>	Input Capacitance	<b>Capacitance</b> V <sub>GE</sub> = 0V, V <sub>CE</sub> = 25V f = 1 MHz		5700		pF	
C <sub>oes</sub>	Output Capacitance			465			
C <sub>res</sub>	Reverse Transfer Capacitance			30			
V <sub>GEP</sub>	Gate-to-Emitter Plateau Voltage	<b>Gate Charge</b> V <sub>GE</sub> = 15V V <sub>CE</sub> = 300V I <sub>C</sub> = 50A		7.5		V	
Q <sub>g</sub>	Total Gate Charge <sup>③</sup>			165		nC	
Q <sub>ge</sub>	Gate-Emitter Charge			40			
Q <sub>gc</sub>	Gate-Collector ("Miller") Charge			50			
SSOA	Safe Operating Area	T <sub>J</sub> = 150°C, R <sub>G</sub> = 5Ω, V <sub>GE</sub> = 15V, L = 100μH, V <sub>CE</sub> = 600V	190			A	
t <sub>d(on)</sub>	Turn-on Delay Time	<b>Inductive Switching (25°C)</b> V <sub>CC</sub> = 400V V <sub>GE</sub> = 15V I <sub>C</sub> = 50A R <sub>G</sub> = 5Ω T <sub>J</sub> = +25°C		19		ns	
t <sub>r</sub>	Current Rise Time			36			
t <sub>d(off)</sub>	Turn-off Delay Time			83			
t <sub>f</sub>	Current Fall Time			60			
E <sub>on1</sub>	Turn-on Switching Energy <sup>④</sup>				465		μJ
E <sub>on2</sub>	Turn-on Switching Energy (Diode) <sup>⑤</sup>				837		
E <sub>off</sub>	Turn-off Switching Energy <sup>⑥</sup>				637		
t <sub>d(on)</sub>	Turn-on Delay Time	<b>Inductive Switching (125°C)</b> V <sub>CC</sub> = 400V V <sub>GE</sub> = 15V I <sub>C</sub> = 50A R <sub>G</sub> = 5Ω T <sub>J</sub> = +125°C		19		ns	
t <sub>r</sub>	Current Rise Time			36			
t <sub>d(off)</sub>	Turn-off Delay Time			116			
t <sub>f</sub>	Current Fall Time			86			
E <sub>on1</sub>	Turn-on Switching Energy <sup>④</sup>				465		μJ
E <sub>on2</sub>	Turn-on Switching Energy (Diode) <sup>⑤</sup>				1261		
E <sub>off</sub>	Turn-off Switching Energy <sup>⑥</sup>				1058		

**THERMAL AND MECHANICAL CHARACTERISTICS**

Symbol	Characteristic	MIN	TYP	MAX	UNIT
R <sub>θJC</sub>	Junction to Case (IGBT)			.20	°C/W
R <sub>θJC</sub>	Junction to Case (DIODE)			N/A	
W <sub>T</sub>	Package Weight			5.90	gm

- ① Repetitive Rating: Pulse width limited by maximum junction temperature.
- ② For Combi devices, I<sub>ces</sub> includes both IGBT and FRED leakages
- ③ See MIL-STD-750 Method 3471.
- ④ E<sub>on1</sub> is the clamped inductive turn-on-energy of the IGBT only, without the effect of a commutating diode reverse recovery current adding to the IGBT turn-on loss. (See Figure 24.)
- ⑤ E<sub>on2</sub> is the clamped inductive turn-on energy that includes a commutating diode reverse recovery current in the IGBT turn-on switching loss. A Combi device is used for the clamping diode as shown in the E<sub>on2</sub> test circuit. (See Figures 21, 22.)
- ⑥ E<sub>off</sub> is the clamped inductive turn-off energy measured in accordance with JEDEC standard JESD24-1. (See Figures 21, 23.)
- ⑦ Continuous current limited by package lead temperature.

**APT Reserves the right to change, without notice, the specifications and information contained herein.**

# TYPICAL PERFORMANCE CURVES

APT50GP60B\_S

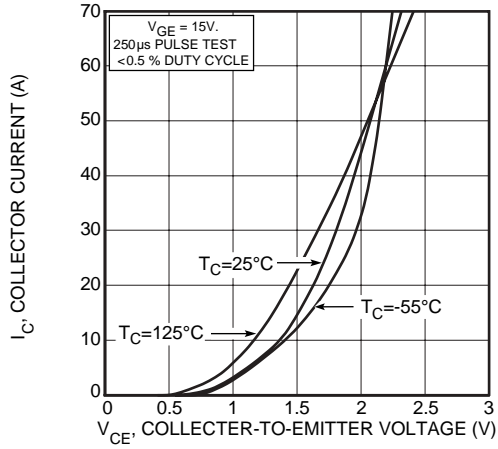

FIGURE 1, Output Characteristics ( $V_{GE} = 15V$ )

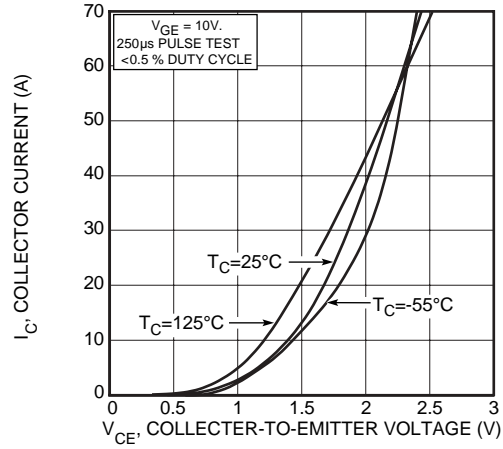

FIGURE 2, Output Characteristics ( $V_{GE} = 10V$ )

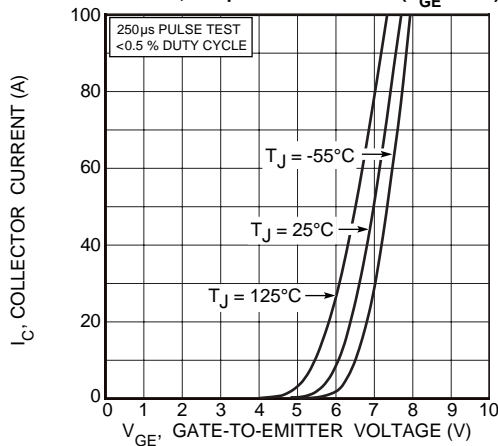

FIGURE 3, Transfer Characteristics

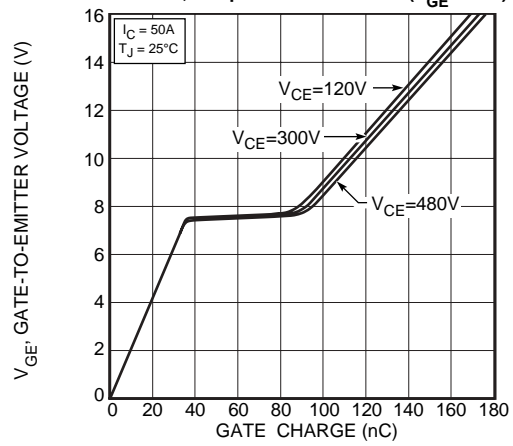

FIGURE 4, Gate Charge

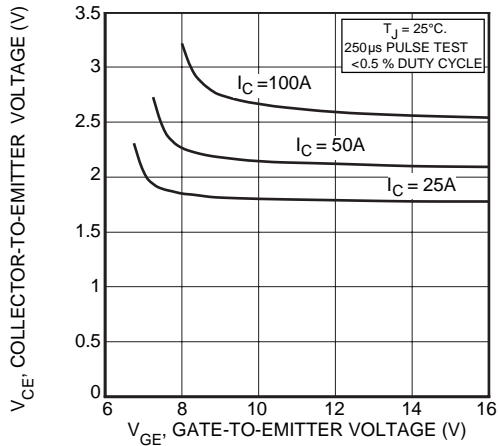

FIGURE 5, On State Voltage vs Gate-to-Emitter Voltage

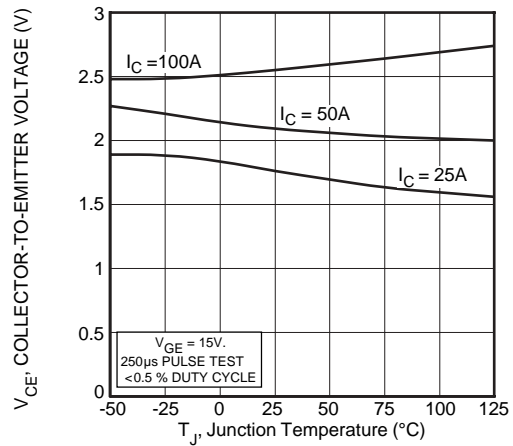

FIGURE 6, On State Voltage vs Junction Temperature

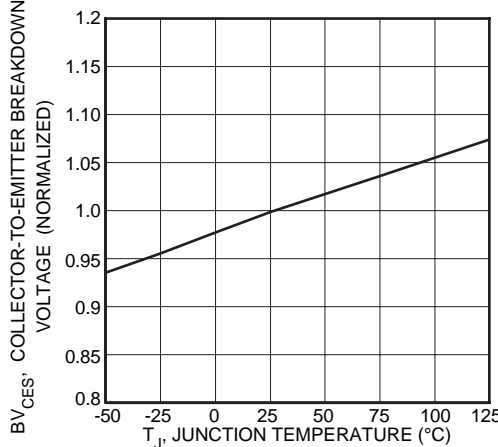

FIGURE 7, Breakdown Voltage vs. Junction Temperature

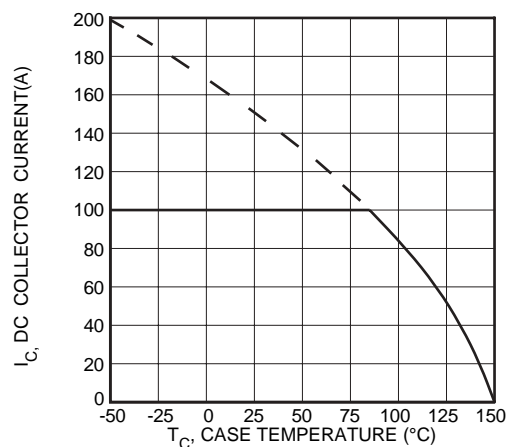

FIGURE 8, DC Collector Current vs Case Temperature

# TYPICAL PERFORMANCE CURVES

APT50GP60B\_S

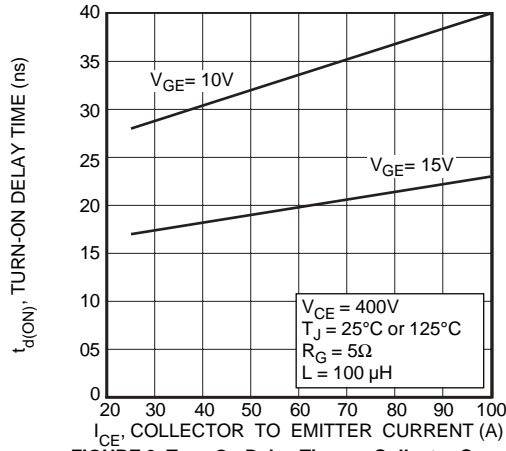

FIGURE 9, Turn-On Delay Time vs Collector Current

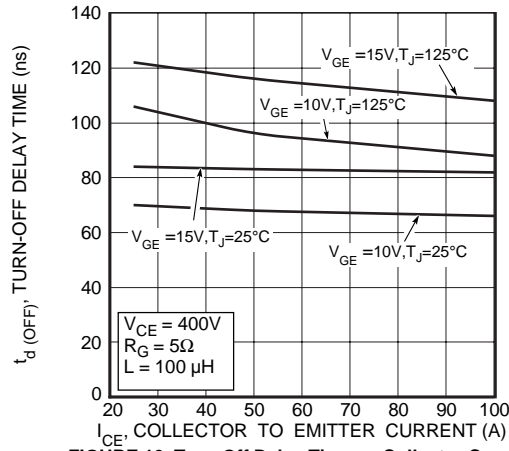

FIGURE 10, Turn-Off Delay Time vs Collector Current

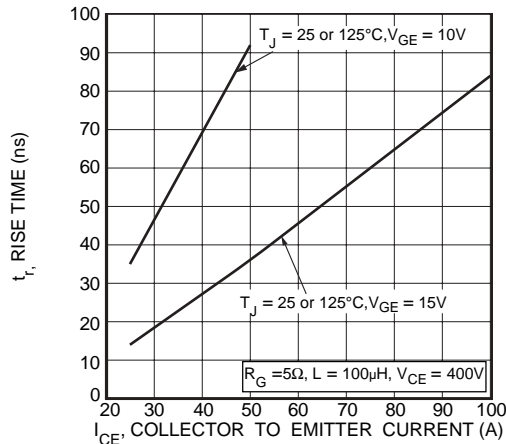

FIGURE 11, Current Rise Time vs Collector Current

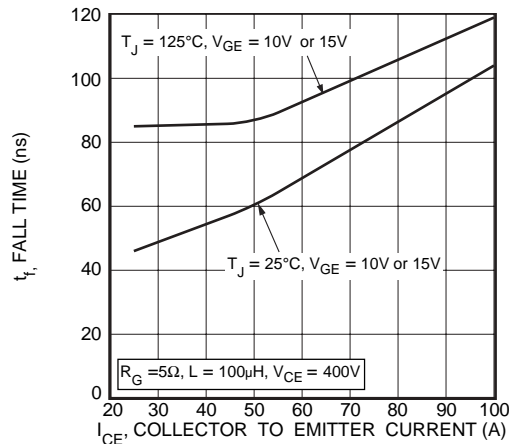

FIGURE 12, Current Fall Time vs Collector Current

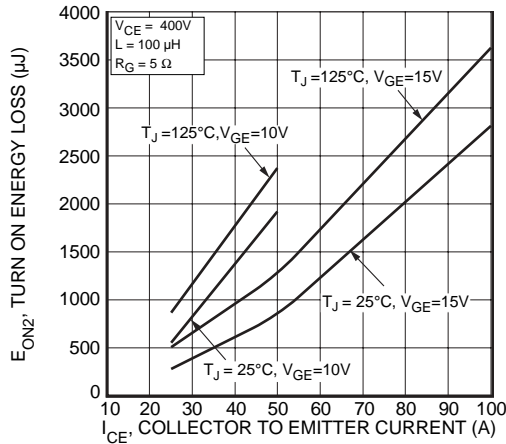

FIGURE 13, Turn-On Energy Loss vs Collector Current

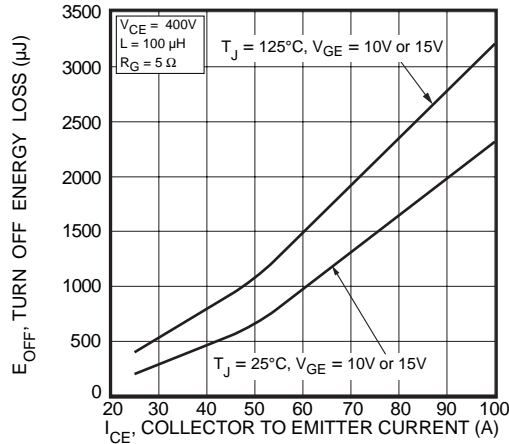

FIGURE 14, Turn Off Energy Loss vs Collector Current

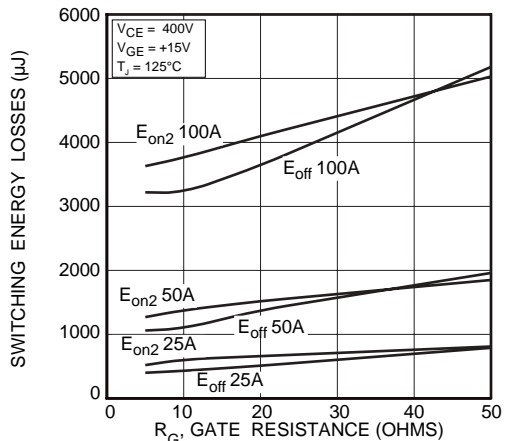

FIGURE 15, Switching Energy Losses vs. Gate Resistance

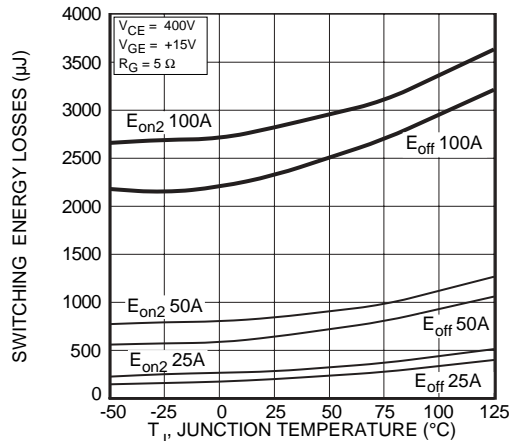

FIGURE 16, Switching Energy Losses vs Junction Temperature

# TYPICAL PERFORMANCE CURVES

APT50GP60B\_S

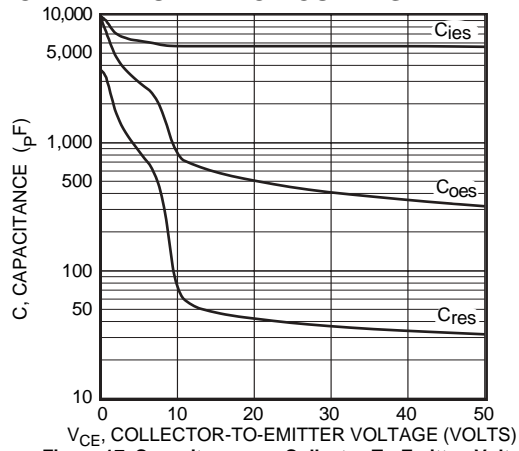

Figure 17, Capacitance vs Collector-To-Emitter Voltage

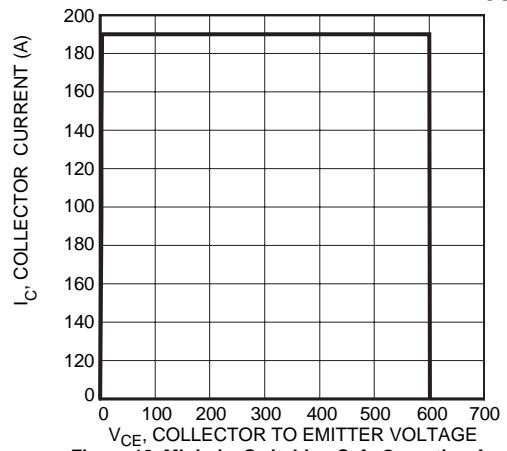

Figure 18, Minimum Switching Safe Operating Area

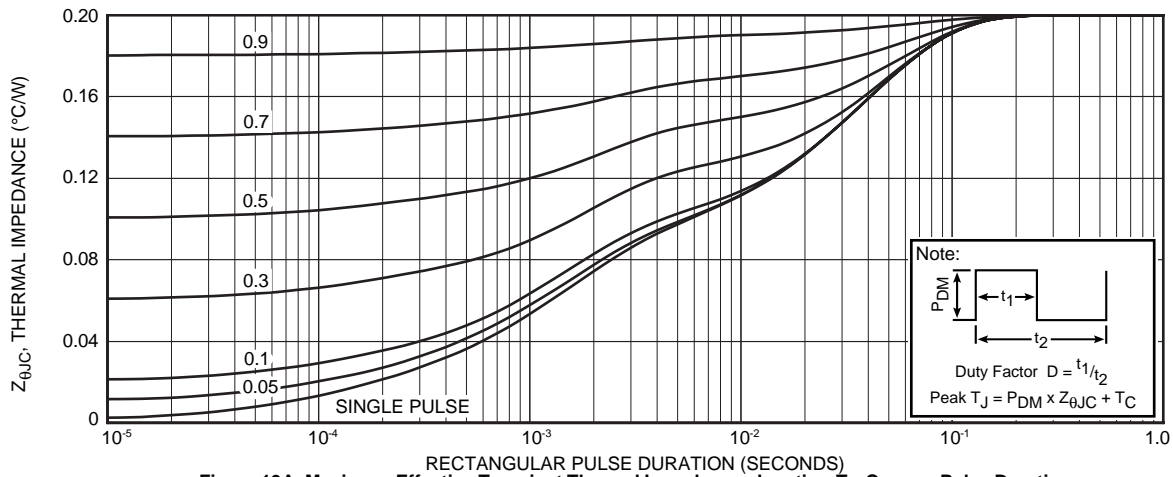

Figure 19A, Maximum Effective Transient Thermal Impedance, Junction-To-Case vs Pulse Duration

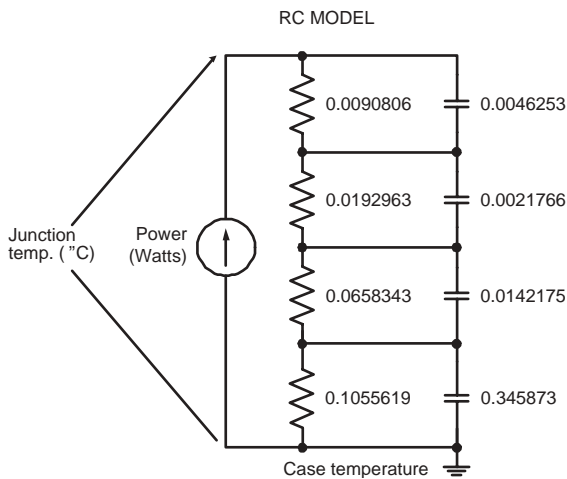

FIGURE 19B, TRANSIENT THERMAL IMPEDANCE MODEL

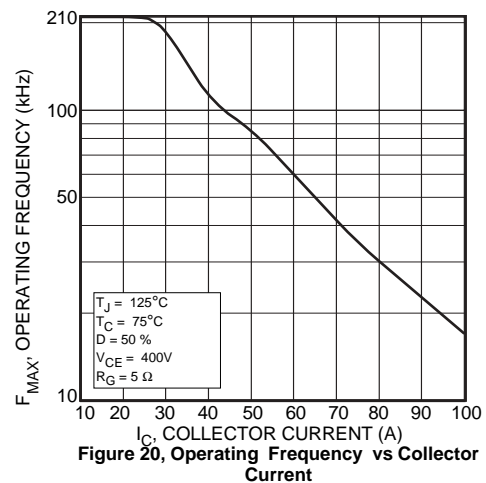

Figure 20, Operating Frequency vs Collector Current

$$F_{max} = \min(f_{max1}, f_{max2})$$

$$f_{max1} = \frac{0.05}{t_{d(on)} + t_r + t_{d(off)} + t_f}$$

$$f_{max2} = \frac{P_{diss} - P_{cond}}{E_{on2} + E_{off}}$$

$$P_{diss} = \frac{T_J - T_C}{R_{\theta JC}}$$

## TYPICAL PERFORMANCE CURVES

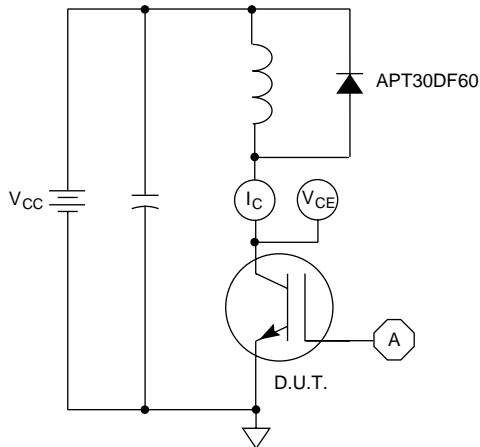

Figure 21, Inductive Switching Test Circuit

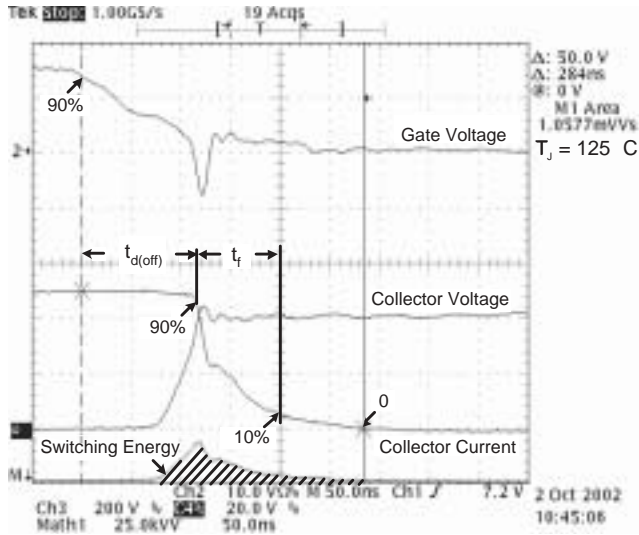

Figure 23, Turn-off Switching Waveforms and Definitions

## APT50GP60B\_S

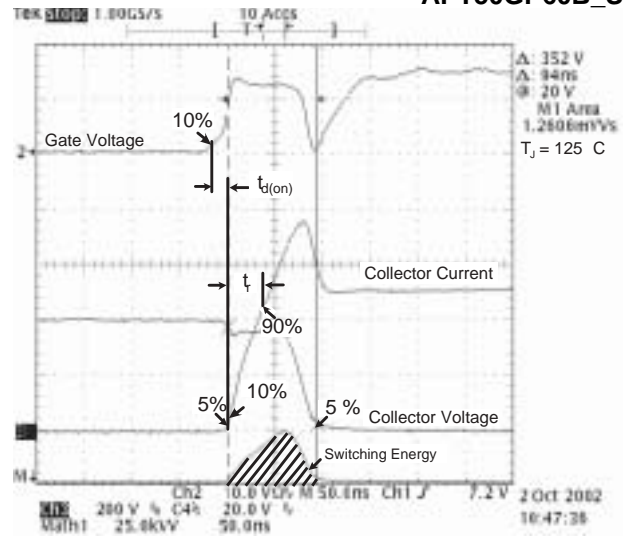

Figure 22, Turn-on Switching Waveforms and Definitions

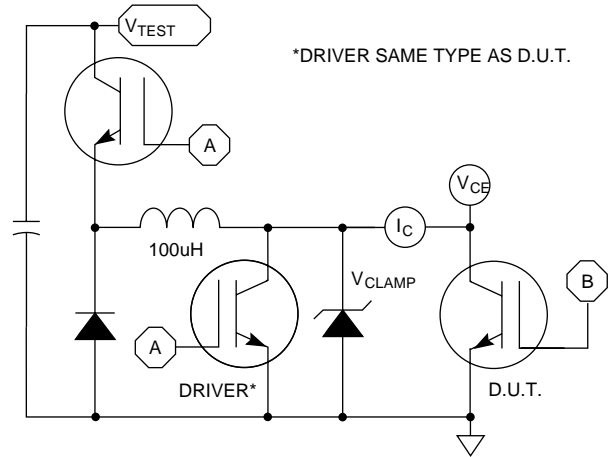
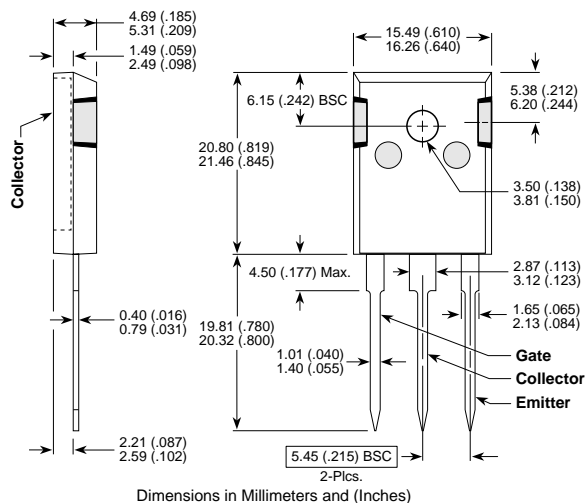

Figure 24,  $E_{ON1}$  Test Circuit

## TO-247 Package Outline



## D<sup>3</sup>PAK Package Outline

